

SEAL COLOR SELECTOR			
BLACK	_____	WHITE	_____
BEIGE	_____	GRAY	_____

B

B

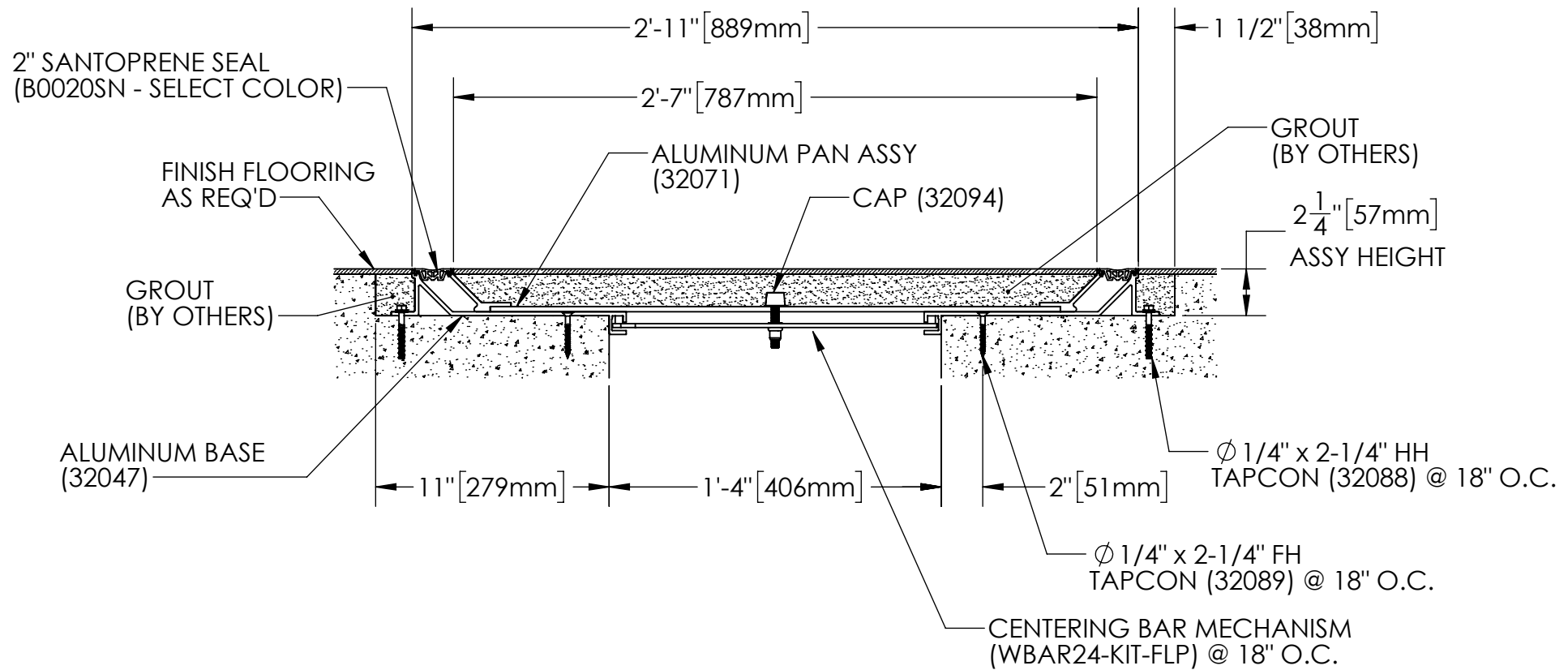

A

A

FLOOR TO FLOOR BLOCKOUT APPLICATION

EXPOSED FINISH: MILL
 MOVEMENT: +/- 50% NOMINAL JOINT WIDTH
 SEAL THERMAL MOVEMENT: +/- 0.50"
 STOCK LENGTHS: 10'-0"

PROJECT:			
ARCHITECT:			
CONTRACTOR:			
QTY:			
PART#:		EJN-FLP-1600	
		TITLE: SEISMIC PAN FLOORING SYSTEM BLOCKOUT APPLICATION	
<small>9300 73rd Ave N., Minneapolis, MN 55428 800-547-2635 info@nystrom.com</small>			
NAME	DATE	SIZE	DWG. NO.
JMS	7/25/23	A	EJN-FLP-1600
RELEASED			WEIGHT:
			SHEET 1 OF 1

PROPRIETARY AND CONFIDENTIAL: THE INFORMATION CONTAINED IN THIS DRAWING IS THE SOLE PROPERTY OF NYSTROM. ANY REPRODUCTION IN PART OR AS A WHOLE WITHOUT THE WRITTEN PERMISSION OF NYSTROM IS PROHIBITED.