

SEAL COLOR SELECTOR	
BLACK _____	WHITE _____
BEIGE _____	GRAY _____

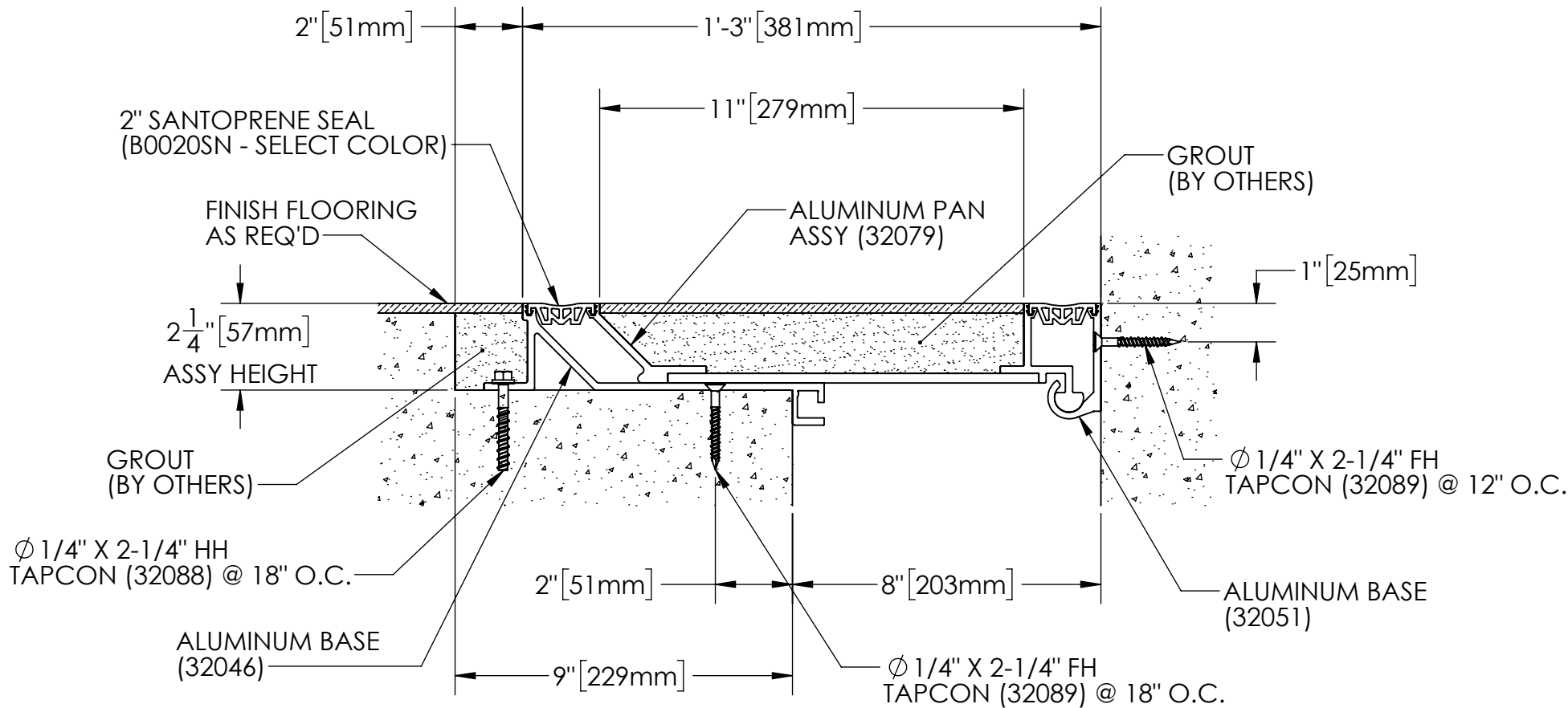

FLOOR TO WALL BLOCKOUT APPLICATION

EXPOSED FINISH: MILL
 MOVEMENT: +/- 50% NOMINAL JOINT WIDTH
 SEAL THERMAL MOVEMENT: +/- 0.50"
 STOCK LENGTHS: 10'-0"

PROJECT:			
ARCHITECT:			
CONTRACTOR:			
QTY:			
PART#:		EJN-FLP-800W	
		TITLE: SEISMIC PAN FLOORING SYSTEM BLOCKOUT APPLICATION	
<small>9300 73rd Ave N., Minneapolis, MN 55428 800-547-2635 info@nystrom.com</small>			
NAME	DATE	SIZE	DWG. NO.
JMS	7/25/23	A	EJN-FLP-800W
RELEASED			WEIGHT:
			SHEET 1 OF 1