

SEISMIC ELASTOMERIC CORRIDOR WALL & CEILING SYSTEM - DRYWALL BEAD APPLICATION

MODEL(S): LCD/LCDw

LCD Wall to Wall / Ceiling to Ceiling Cover System

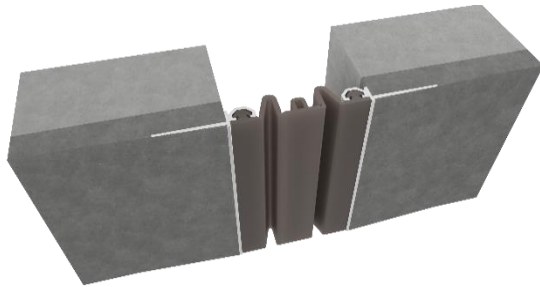

GENERAL DESCRIPTION

This Seismic Elastomeric Drywall System limits the sight line of the expansion joint by using a drywall bead to mount the system outside the joint opening with a finished tape and mud process. The finished seal comes in four colors to match your surroundings and finish material.

GENERAL SAFETY PRECAUTIONS Improper selection, installation, or use can cause personal injury or property damage. It is solely the responsibility of the user, through their own analysis, to select products suitable to the specific application requirements, ensure proper maintenance and use as intended. Follow local, state, and federal regulations for proper installation and operation requirements.

Introduction + Safety

Please read the complete instructions carefully before beginning any work. To ensure proper installation and performance of the product, the following actions must be completed by the installing contractor. Failure to do so will affect product warranty.

Transportation + Storage

- Inspect all shipments and materials for missing or damaged components and hardware.
- Material must be stored in a clean, dry location.

Preparation

- Locate the packing slip(s) and/or shop drawings.
- Verify that all products listed on the packing slip are included in the package.
- Check the products for damage. If products are damaged, report a freight claim immediately and leave the products in their packaging. If you sign for products without reporting damage, you waive your right to a freight claim and will be responsible for their replacement cost.

- Read the instructions thoroughly before beginning installation.

Tool List

- Tape measure
- Chop saw to cut product to length
- Electric drill with 5/32" masonry bit & 3/16" metal bit
- Utility knife

Preinstallation

1. Ensure that the area where the expansion system is being installed is smooth and level.

INSTALLATION

1. Position base member frames in expansion joints per shop drawings. Attach with screws (by installer) through the gypsum wallboard and into the structural support. If attaching into concrete, use the frames as a template, mark, and drill Ø5/32" holes in the concrete. Install base member frames with Ø3/16" Tapcon fasteners (by installer). **See Figure 1.**

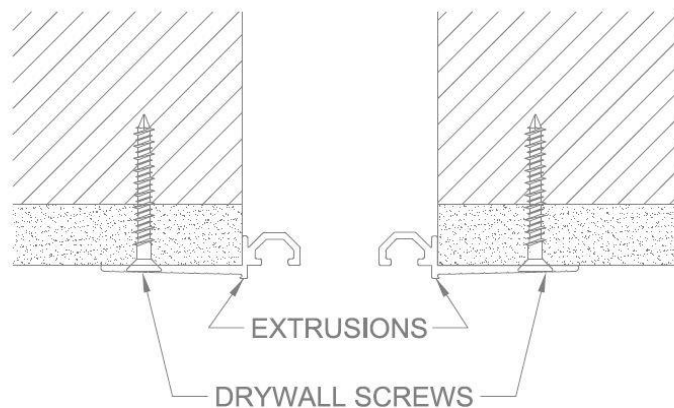

FIGURE 1

2. Position the elastomeric seal into position and push the seal bulbs into the extrusion channels as shown. Make sure the bulbs are seated all the way into the channel. Do not stretch the seal lengthwise during installation. **See Figure 2.**

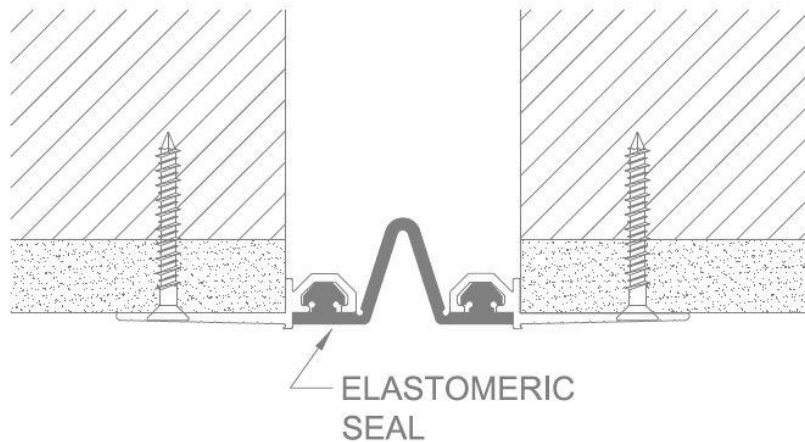

FIGURE 2

3. Protect the elastomeric seal with tape and feather joint compound (by installer) over the exposed aluminum frames and onto the gypsum wallboard. Remove tape after wall or ceiling has been finished. **See Figure 3.**

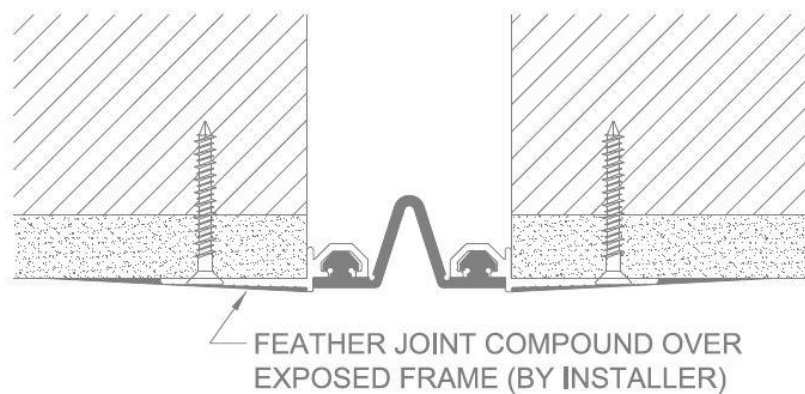
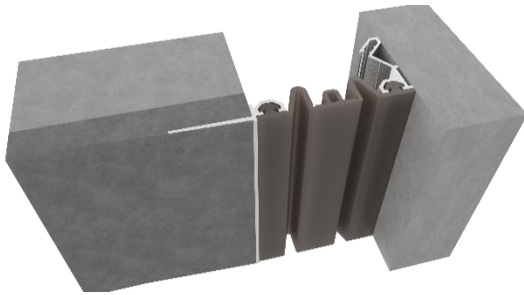

FIGURE 3

LCDw Wall to Corner / Ceiling to Corner Cover System



GENERAL DESCRIPTION

The LCDw Seismic Elastomeric Drywall System is designed to match the LCD system in corner applications.

Preinstallation

1. Ensure that the area where the expansion joint system is being installed is smooth and level.

INSTALLATION

1. Position base member frame in expansion joint per shop drawings. Attach with screws (by installer) through the gypsum wallboard and into the structural support. Position the wall frame into position, making sure the top channel is level with the top channel of the base frame. Attach the wall frame to the wall with appropriate fasteners (by installer) for the wall type at 18" O.C. See **Figure 4**.

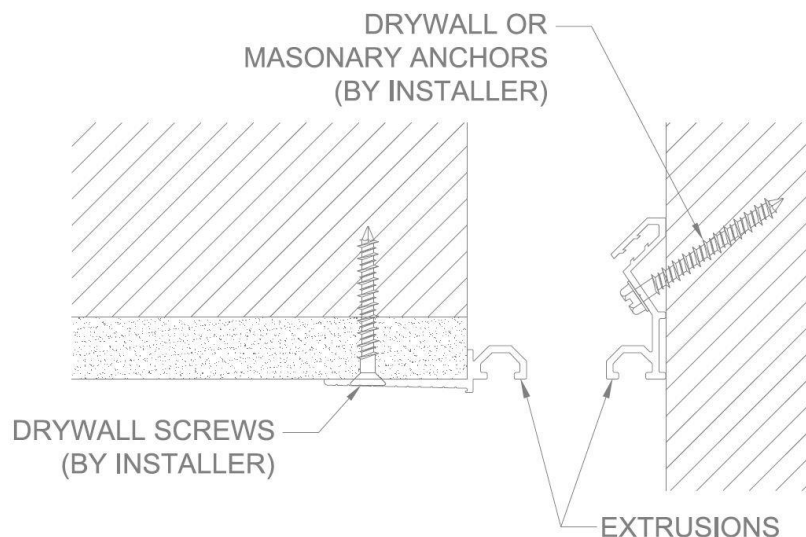

FIGURE 4

2. Position the elastomeric seal into position and push the seal bulbs into the base frame and wall frame top channels as shown. Make sure the bulbs are seated all the way into the channel. Do not stretch the seal lengthwise during installation. **See Figure 5.**

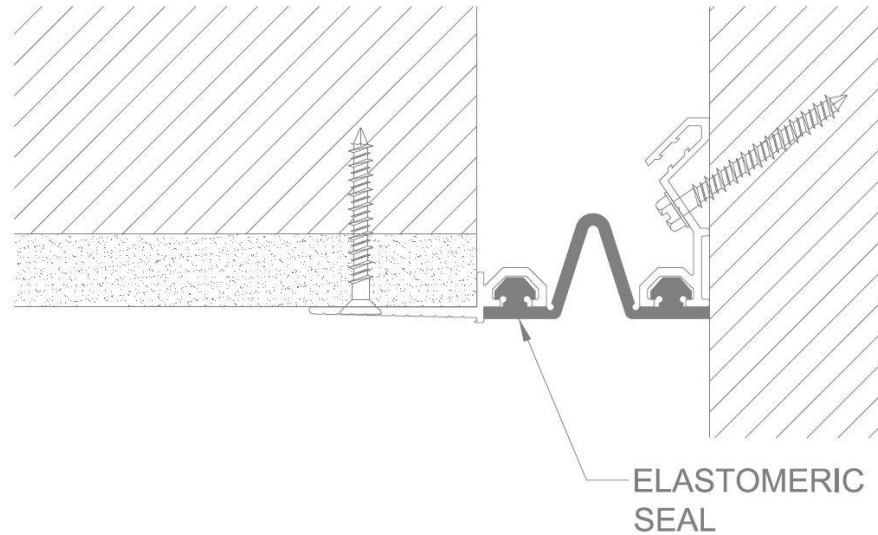

FIGURE 5

3. Protect the elastomeric seal with tape and feather joint compound (by others) over the exposed aluminum frames and onto the gypsum wallboard. Remove tape after wall or ceiling has been finished. **See Figure 6.**

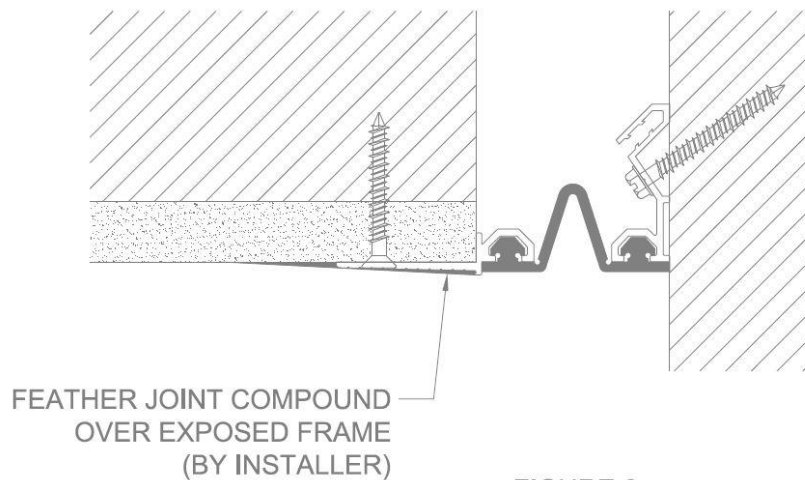

FIGURE 6

FIELD SPLICE FOR ELASTOMERIC V-SEAL

1. After determining the angle needed, use a miter box and a non-serrated saw (teeth removed) and cut ends of seal clean, straight and square. **See Figure 1**

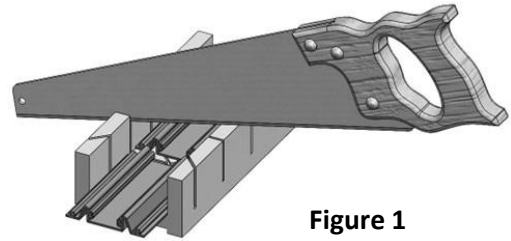

Figure 1

2. After donning the proper PPE, use a solvent (by others) that is safe for elastomeric materials and clean any residual material from the cut ends of the seals. Allow to dry prior to Step #3.

See Figure 2

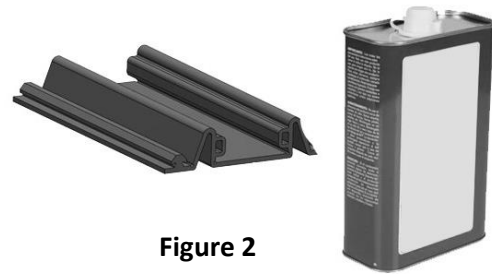

Figure 2

Straight Butt Splice

Insert splice clips (if required) (part # 27511) halfway into the alignment holes on one of the seals. Apply glue, cyanoacrylate or similar adhesive (by others) to both seal ends and follow instructions by the adhesive manufacturer. Almost immediately after adhesive is applied, insert the

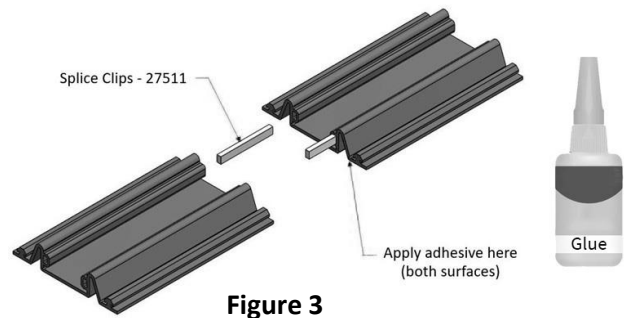

Figure 3

protruding ends of the splice clips into the ends of the two seals together, applying uniform pressure for at least two minutes while maintaining contact between both sides. The splice clip is not necessary, but is recommended, especially on larger sized seals. **See Figure 3**

Vertical Outside Splice

Insert splice clips (if required) (part # 28090) halfway into the alignment holes on one of the seals. Apply glue, cyanoacrylate or similar adhesive (by others) to both seal ends and follow instructions by the adhesive manufacturer. Almost immediately after adhesive is applied, insert the protruding ends of the splice clips into the ends of the two seals together, applying uniform pressure for at least two minutes while maintaining contact between both sides. The splice clip is not necessary, but is recommended, especially on larger sized seals. **See Figure 4**

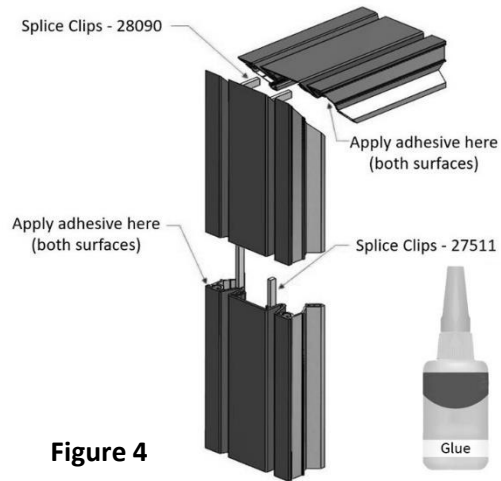

Figure 4

Vertical Inside Splice

Insert splice clips (if required) (part # 28090) halfway into the alignment holes on one of the seals. Apply glue, cyanoacrylate or similar adhesive (by others) to both seal ends and follow instructions by the adhesive manufacturer. Almost immediately after adhesive is applied, insert the protruding ends of the splice clips into the ends of the two seals together, applying uniform pressure for at least two minutes while maintaining contact between both sides. The splice clip is not necessary, but is recommended, especially on larger sized seals. **See Figure 5**

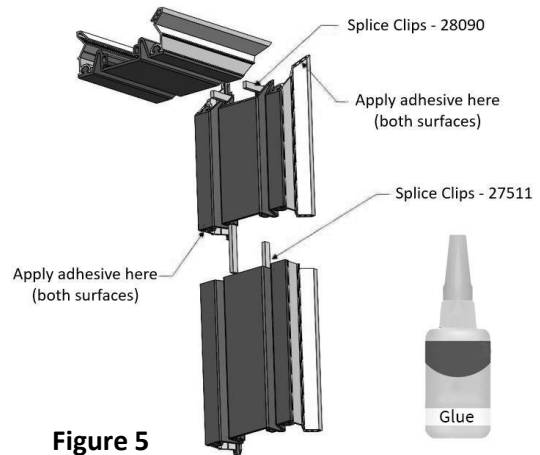

Figure 5

Horizontal Splice

Insert splice clips (if required) (part # 28091) halfway into the alignment holes on one of the seals. Apply glue, cyanoacrylate or similar adhesive (by others) to both seal ends and follow instructions by the adhesive manufacturer. Almost immediately after adhesive is applied, insert the protruding ends of the splice clips into the ends of the two seals together, applying

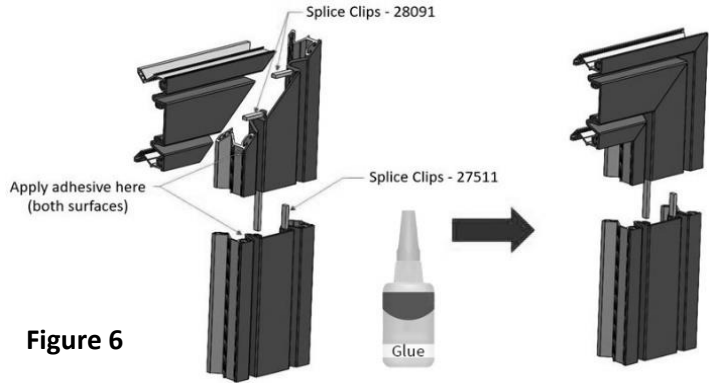

Figure 6

uniform pressure for at least two minutes while maintaining contact between both sides. The splice clip is not necessary, but is recommended, especially on larger sized seals. **See Figure 6**

3. Recheck the splices after the adhesive has cured and reapply adhesive as necessary. Allow 15 minutes prior to installation of seal. Allow 24 hours for adhesive to fully cure and achieve proper working strength. Ensure that the splice of the seal is not within 2" of a joint in the aluminum extrusion, if possible.

See Figure 7

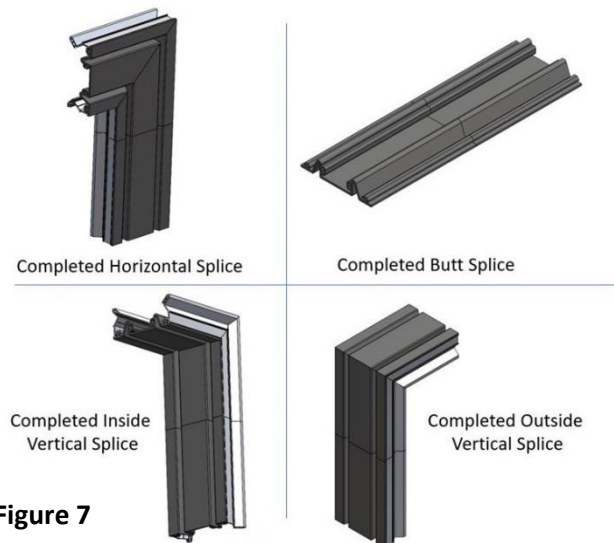

Figure 7

OPERATION

Expansion Joints are designed and built for years of dependable service.

MAINTENANCE

Annual inspections should be performed to make sure the system is still in position. Repair and/or replace as needed.

QUESTIONS?

For more information on installation, repair, or replacement, please contact Customer & Sales Support at 800-547-2635 or visit nystrom.com