

FLOOR DOOR, NON-DRAINABLE DIAMOND TREAD, 300PSF

Model: FDNP SFL/DFL



Pedestrian Floor Door designed for standard-duty load and provides a flush installation for new concrete applications. Ideal use for utility and general building applications where water infiltration is not a concern.

Floor Door products are designed and built for years of service and weather tight access for personnel and equipment. The following are general instructions for installing, operating, and maintaining floor door products.

These are recommended general guidelines only. Locally accepted installation, mounting, and sealing procedures should be followed to ensure the ultimate structural integrity of the installed floor doors.

Special care is required when handling and installing floor doors. Please make sure that all framework and doors are supported during transport and installation to insure against bending or racking of the floor door.

GENERAL SAFETY PRECAUTIONS Improper selection, installation, or use can cause personal injury or property damage. It is solely the responsibility of the user, through their own analysis, to select products suitable to the specific application requirements, ensure proper maintenance and use as intended. Follow local, state, and federal regulations for proper installation and operation requirements.

Introduction + Safety

Please read the complete instructions carefully before beginning any work. To ensure proper installation and performance of the product, the following actions must be completed by the installing contractor. Failure to do so will affect product warranty.

Transportation + Storage

- Inspect all shipments and materials for missing or damaged components and hardware.
- Material must be stored in a clean, dry location.
- Floor doors are shipped with the intent for installation within 30 days.
- If storage is required, ensure the floor doors are stored flat, covered, and indoors.

- If stored outside, the floor door frames can expand and contract causing the protective coating to crack and chip.
- If the units are stored outside and the result is cracked primer, a primer coat must be re-applied before the unit is cast-in concrete. Scrape and clean the affected surface and apply Rust-Oleum prior to installation.

Preparation

- Locate the packing slip(s) and/or shop drawings.
- Verify that all products listed on the packing slip are included in the package.
- Check the products for damage. If products are damaged, report a freight claim immediately and leave the products in their packaging. If you sign for products without reporting damage you waive your right to a freight claim and will be responsible for their replacement cost.
- Read the instructions thoroughly before beginning installation.

Set Up / Unpack

Warning: Floor Door covers are spring loaded. Ensure proper orientation prior to releasing slam latch. Do not release latch in upside down position.

- Orient the floor door in an upright position as shown. This is the correct position to handle the floor door.
- Visually inspect slam latch from the underside to ensure latch bolt is engaged over frame.
- Cut plastic tie wrap and remove envelope.



OPEN IN THIS POSITION

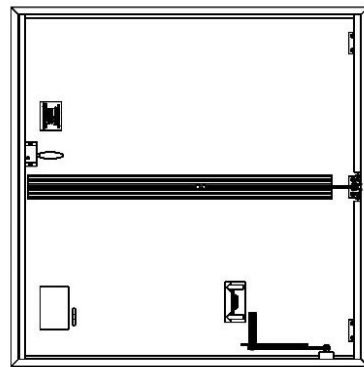

DO NOT OPEN IN THIS POSITION

Tool List

- 1/2-inch Wrench
- Adjustable Wrench

INSTALLATION - Concrete, Cast-In Place

1. Set frame in the opening

NOTE: The inside opening of the frame is the “opening size”.

- a. Secure the floor door into the desired area with welding, bolting or other anchorage, making sure not to interfere with the operation of the hatch.
2. Square frame
 - a. It is vital that the frame remains square and straight during the concrete pour.

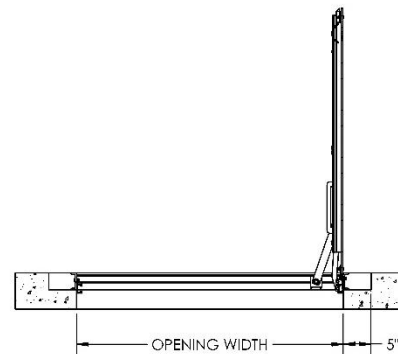
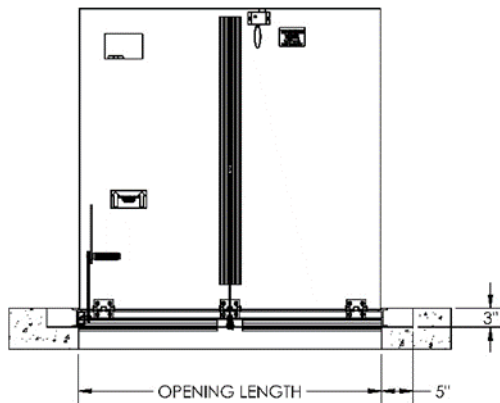

3. Protect exposed aluminum from wet cement.
 - a. To ensure a good quality installation and prevent staining, alkaline building materials such as cement should be removed quickly from aluminum surfaces.

4. Pour cement
 - a. Pour cement to the top edge of the frame, leveling to finish flush with the top flange of the floor door. Allow concrete to cure for seven (7) days prior to operating the floor door. Operating the unit prior may crack the concrete.

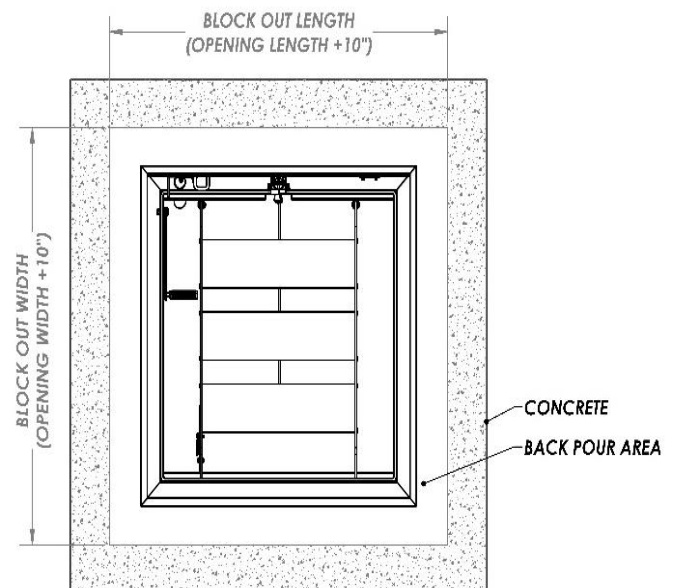

- b. After 7 day curing period, open the door(s) and inspect the unit for excess concrete that may have seeped or fallen into the hinges, or latch. Remove any concrete to ensure smooth operation.

5. Engage springs

NOTE: Large units with two or more springs per door may be shipped with the spring loose within the housing. These springs must be secured in place before operating the door.

- a. Manually open the door to the 90-degree position. The hold open arm (HOA), will automatically hold the door open.
- b. While in the 90-degree position the spring should settle on the plate at the bottom of the housing.
- c. Slide the top spring plate (**Illustration A**) down until it touches the top of the spring. Using a 1/2-inch wrench tighten the two hex head screws.
- d. Disengage the hold open arm to test the closing and opening operation. The door should slowly begin to close requiring assistance to fully shut.

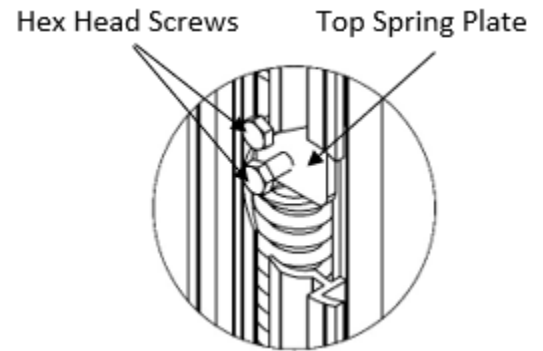

Illustration A

6. Adjust spring tension (optional)

NOTE: Tension is factory set. Adjust only if field conditions require more or less tension.

- a. Open the door to the 90-degree position, the HOA will automatically hold the door open.

The spring link bracket (**Illustration B**) allows spring tension adjustment by changing the position of the cotter pin link connection. The lowest position puts the least amount of tension on the spring.

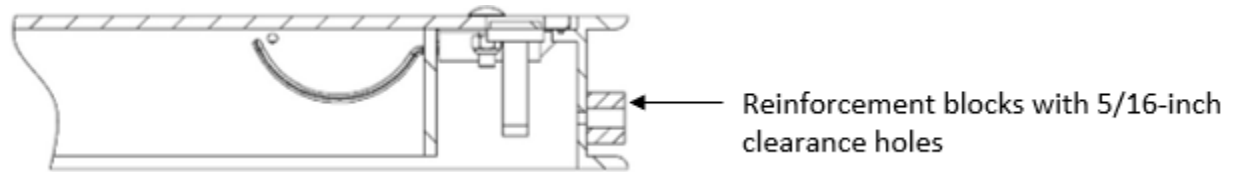

Illustration B

- b. First, disengage the spring by loosening the two hex head screws at the top of the spring (**Illustration A**).
- c. Remove the cotter pin and move the spring link into the desired position. Replace the cotter pin and re-tighten the hex head screws.

INSTALLATION - Bolt-In Wood and Metal Openings

Note: Floor doors built for bolt-in installation are provided with 2-inch by 2-inch welded mounting brackets that have clearance holes for 5/16-inch hardware. All mounting hardware provided by others.



1. Set frame in opening
 - a. Set the door into the desired opening area and mark where fastener holes are located on the mounting surface. For existing concrete openings, 5/16-inch anchor bolts are recommended. For existing wood openings 5/16-inch lag bolts are recommended.
2. Drill holes in the mounting surface
 - a. Remove the floor door and drill holes into the mounting surface at the marked locations.
3. Secure the floor door to the mounting surface
 - a. With two or more people, hold the floor door in place and secure to the mounting surface with bolts (provided by others).
4. Adjust spring if necessary, see steps 5 and 6 on page 4.

OPERATION

Floor doors are designed and built for years of dependable access. The Non-Drainable, Pedestrian doors are manufactured from aluminum. All floor doors come standard with stainless steel hardware components. The basic components for door operation include turn handle latches, compression springs, stainless steel hinges and a locking hold open arm as detailed:

- Latch: 316 Stainless Steel (SST) slam latch with interior rotating handle, and exterior L-handle key
- Spring: Compression springs to ensure ease of opening and closing during use.
- Hinge: Stainless Steel hinges
- Hold Open Arm: Locking hold open arm automatically engages and locks when the door fully opens. The hold open arm must be engaged in the locked position to ensure that the door does not close unintentionally. Pull the red vinyl grip handle to unlock and safely close the door.

Opening Fully Installed Door

To open the floor door cover, use the slam latch L-handle key and rotate the slam latch. The cover will un-latch and the spring will begin to lift the door. Use the key to fully pull open the door. The hold open arm engages and locks the cover in the 90-degree open position.

Closing Fully Installed Door

To close the floor door cover, push down. Slam the door slightly to ensure proper latch engagement.

MAINTENANCE

- Floor doors should be manually operated at minimum twice per year to check performance.
- Lubricate moving parts such as hinges, and latches with a food grade grease or silicone spray lube as required to maintain a smooth opening and closing of the door. Do not over grease. Do not use regular lubricating oil as it can attract dust and grit.
- Non-moving parts should be cleaned with a mild soap or dishwashing detergent and water solution.
- Gaskets should be cleaned with a clean, damp, lint-free cloth. Do not apply mineral oils, vinyl dressings, or other lubricants to the gasket as they may cause the gasket to break down over time.
- If floor doors are installed in corrosive environments such as environments exposed to salt water and or hydrogen chloride, the stainless-steel hardware must be coated with a custom finish and the springs should be lubricated on a strict 3 to 6 month schedule.
- If any questions arise during the operation or maintenance of the products, please feel free to call technical assistance.

QUESTIONS?

For more information on installation, repair, or replacement, please contact Customer & Sales Support at 800-547-2635 or visit nystrom.com

PARTS LIST

#	Part Number	Description
1	FD-KIT-KEY18	Latch Key
2	FD-KIT-SLAMLATCH	Slam Latch
3	FD-KIT-HINGE	Hinge
4	FD-KIT-SPRING40-18	Spring
5	FD-KIT-SPRING80-18	Spring
6	FD-KIT-HOA18	Hold Open arm
7	FD-KIT-SPFRAMEMOUNT18-N	Frame Mount Spring
8	FD-KIT-GASKET18N	Angle Frame Gasket

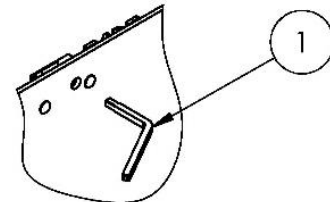

LATCH DETAIL

